

ΚΥΚΛΩΜΑΤΑ VLSI

Πανεπιστήμιο Ιωαννίνων



Τμήμα Μηχανικών Η/Υ και Πληροφορικής



Κεφάλαιο 3^ο

Γ. Τσατούχας



ΚΥΚΛΩΜΑΤΑ VLSI

Διάρθρωση



VLSI Systems
and Computer Architecture Lab

1. Κατασκευή ολοκληρωμένων κυκλωμάτων
2. Φυσικός σχεδιασμός
3. Τεχνολογίες τριπλών πηγαδιών – SOI
4. Αντιστάσεις – Πυκνωτές – Πηνία
5. Μνήμες – MEMS

CMOS Τεχνολογία

2

Κατασκευή Ολοκληρωμένων Κυκλωμάτων

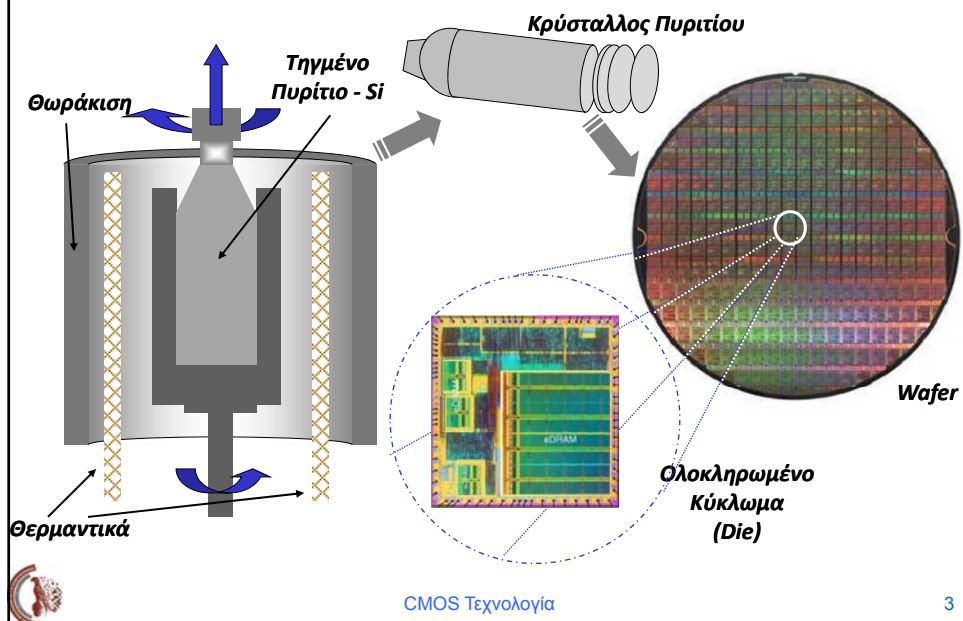

Διαδικασία Χάραξης στο Πυρίτιο I

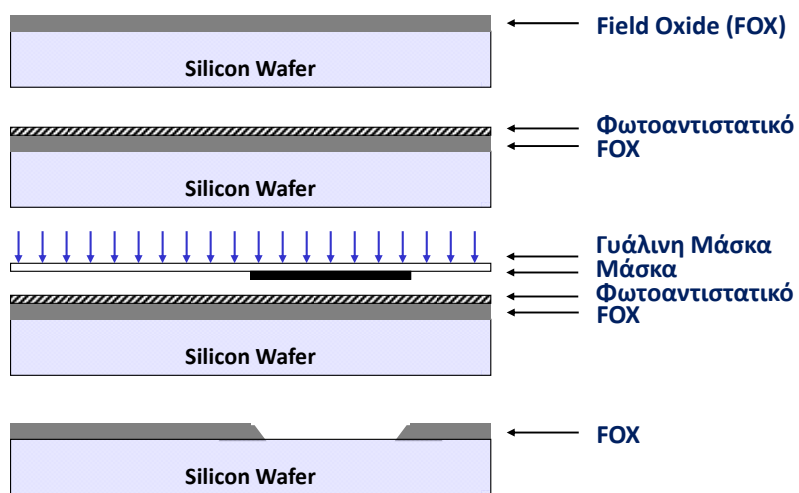

CMOS Τεχνολογία

4

Διαδικασία Χάραξης στο Πυρίτιο II



Κατασκευή Τρανζίστορ I

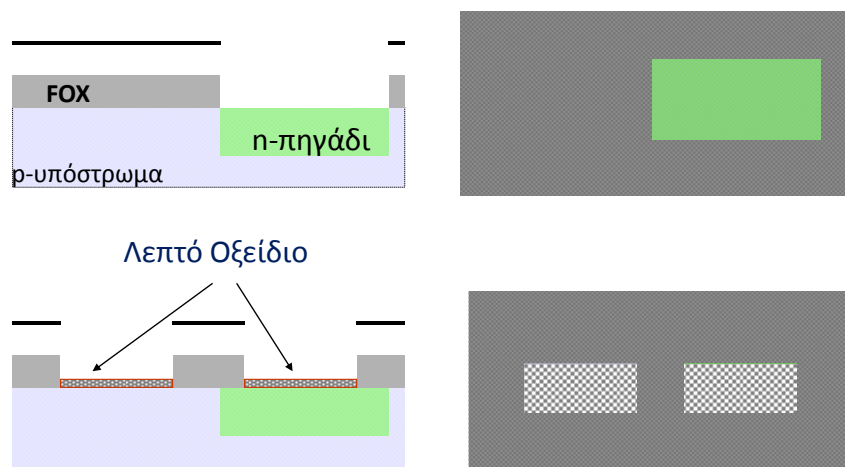

Κατασκευή Τρανζίστορ II

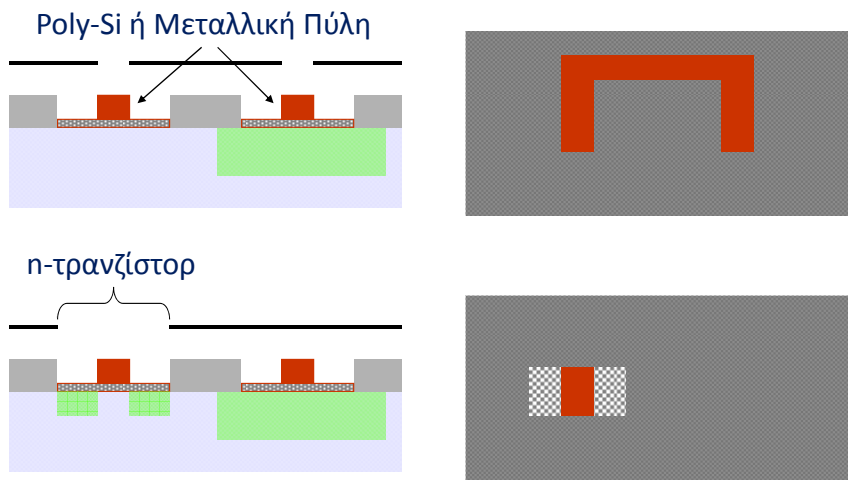

CMOS Τεχνολογία

7

Κατασκευή Τρανζίστορ III

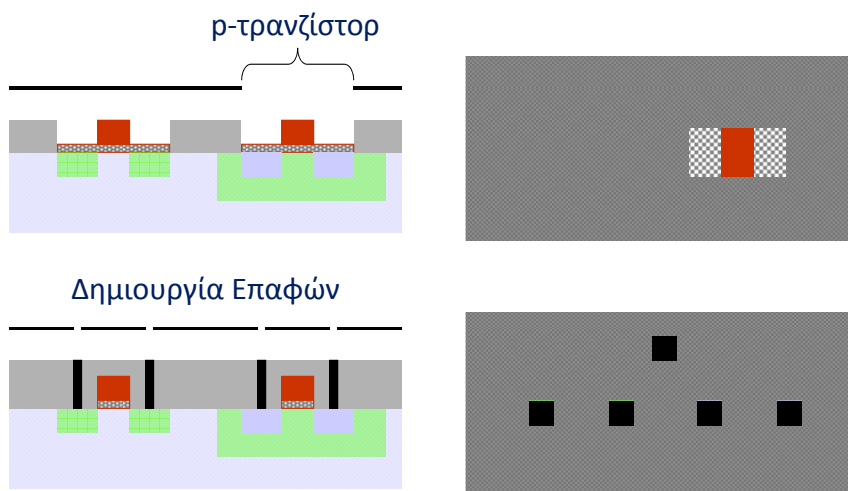

CMOS Τεχνολογία

8

Κατασκευή Τρανζίστορ IV

Στρώση Μετάλλου 1

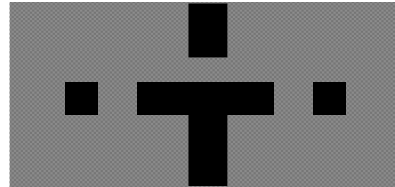
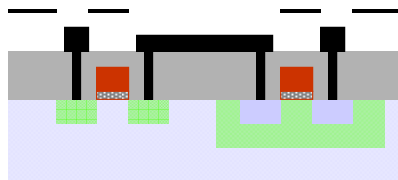

Στρώση Μετάλλου 2

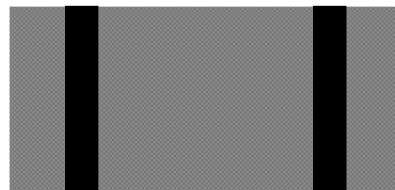
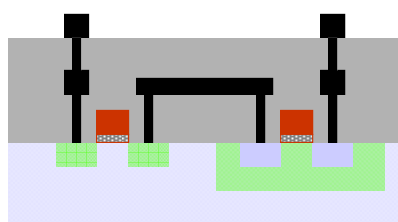

CMOS Τεχνολογία

9

Φυσικός Σχεδιασμός I

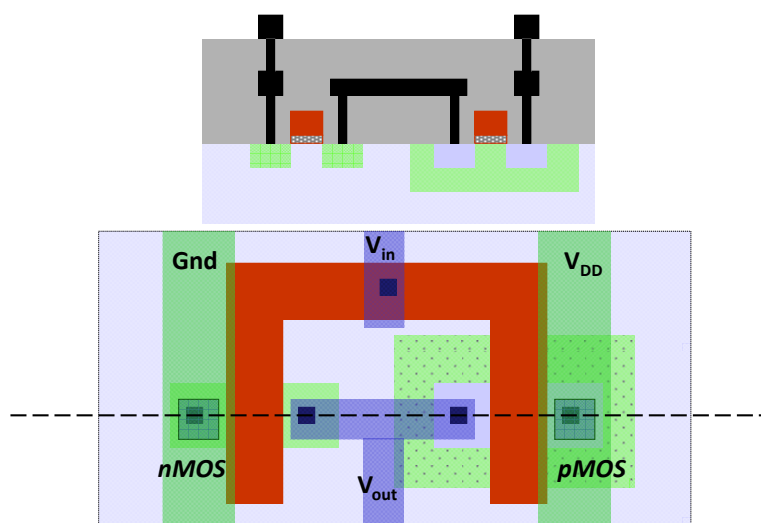

CMOS Τεχνολογία

10

Φυσικός Σχεδιασμός II

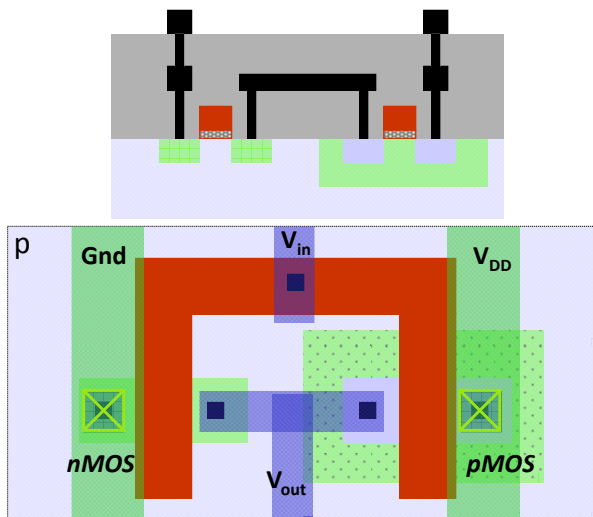

CMOS Τεχνολογία

11

Δομή Τρανζίστορ

Τρανζίστορ

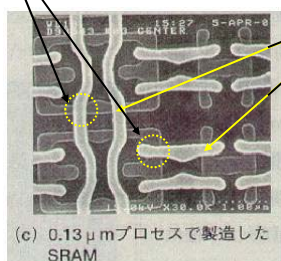

Poly or metal

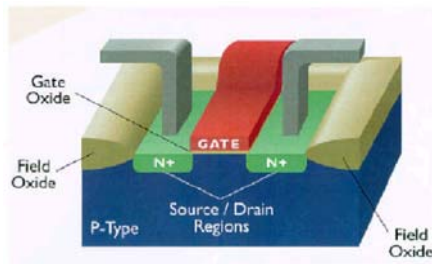
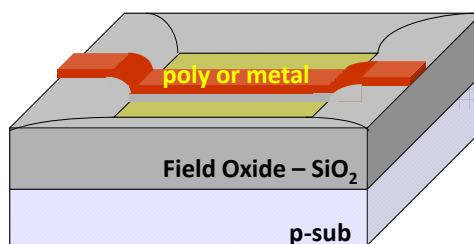

CMOS Τεχνολογία

12

SEM Φωτογραφίες

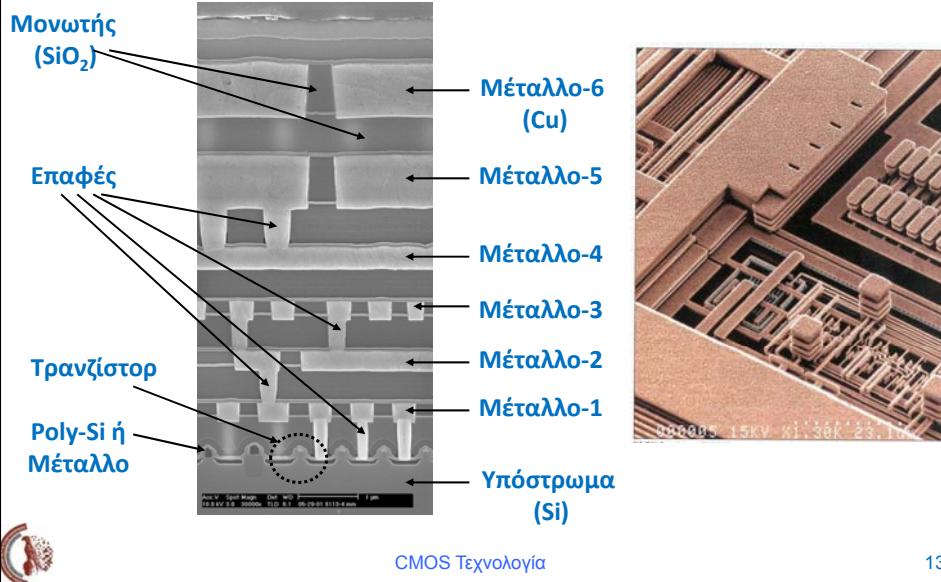

Φυσικός Σχεδιασμός Σύνθετης Πύλης

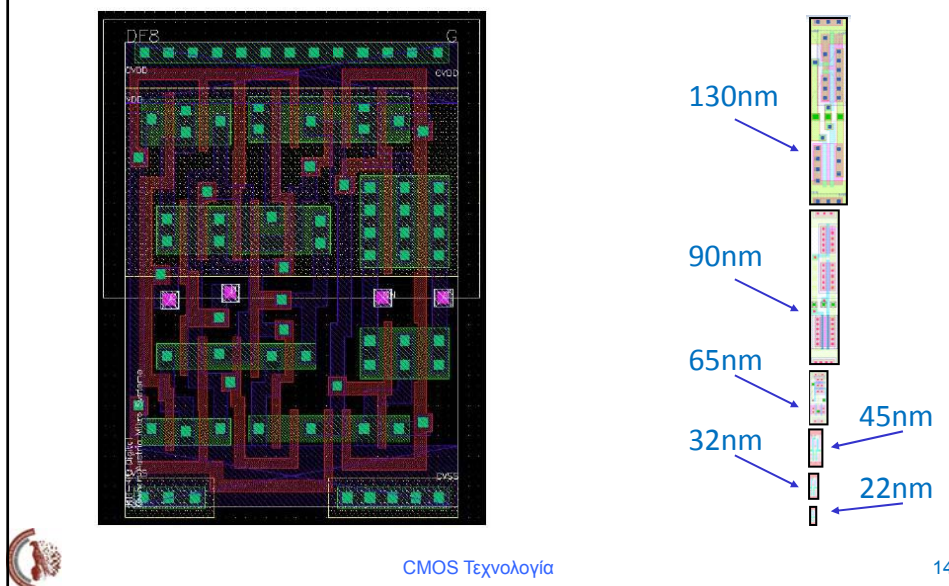

Σχηματικό και Φυσικός Σχεδιασμός

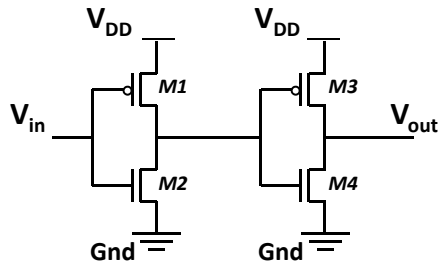

Σχηματικό Κυκλώματος

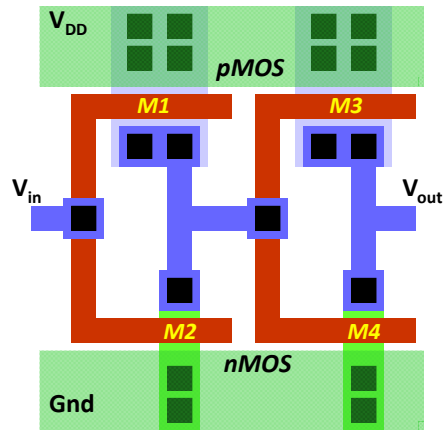

Φυσικός Σχεδιασμός (layout)



Φυσικός Σχεδιασμός – Κατασκευή

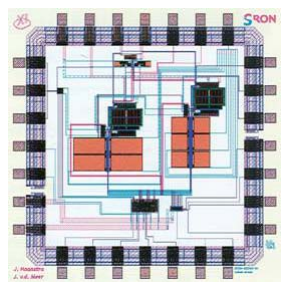

Φυσικός Σχεδιασμός

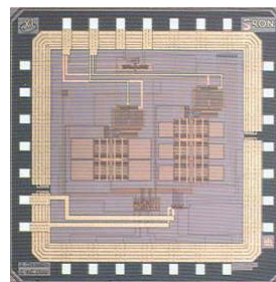

Μικροφωτογραφία
Κατασκευασμένου Κυκλώματος



Τεχνολογίες Τριπλών Πηγαδιών

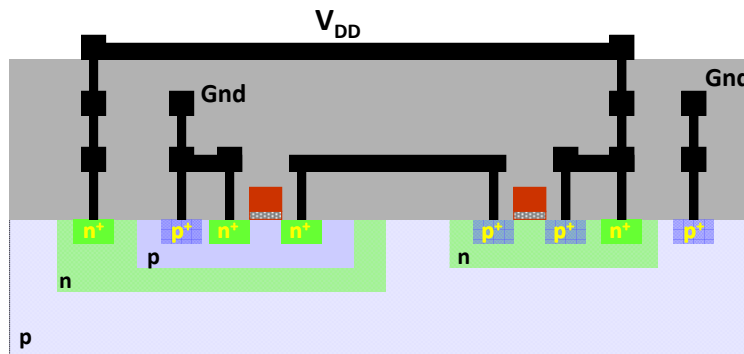

CMOS Τεχνολογία

17

Silicon on Insulator - SOI

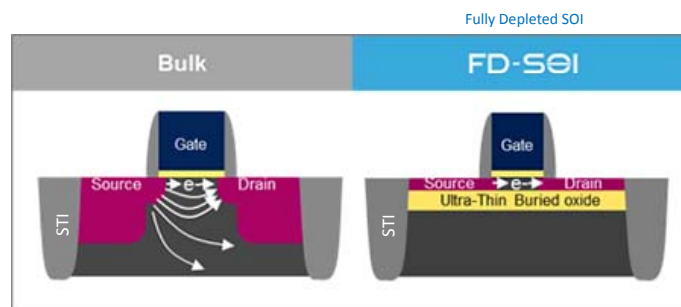

ST-Microelectronics

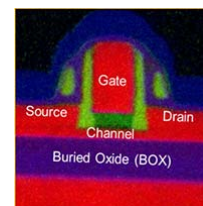

CMOS Τεχνολογία

18

Αντιστάσεις - Πυκνωτές

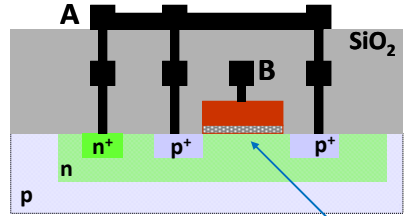
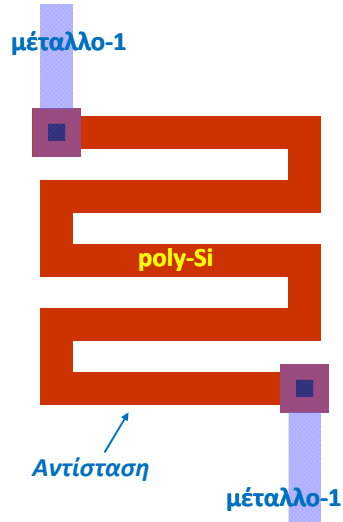

Πυκνωτής

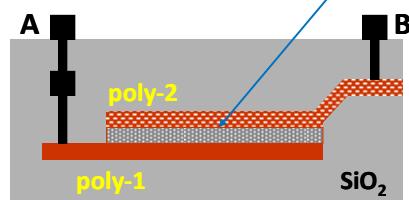

Πηνία

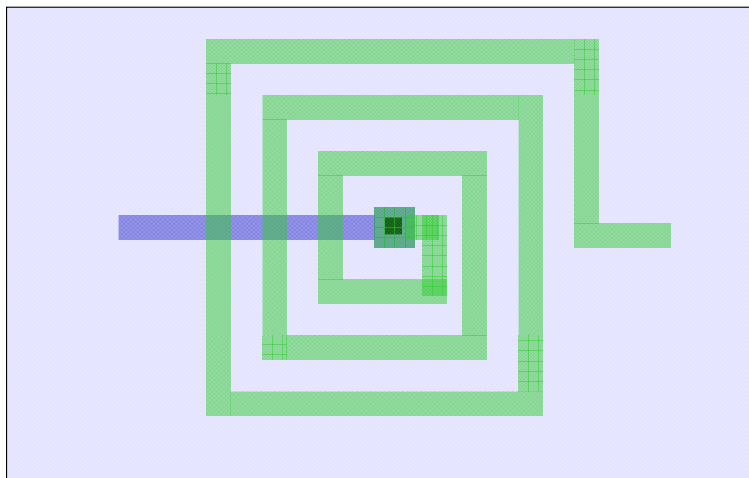

Πυκνωτές Δυναμικών Μνημών

Πυκνωτής Τάφρου
Trench Capacitors

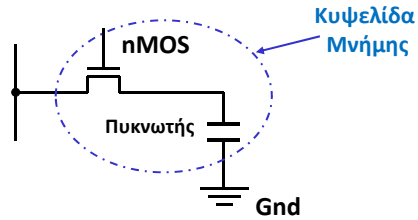
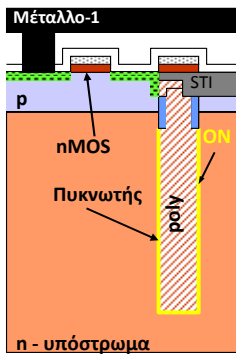

Πυκνωτές Επιφανείας

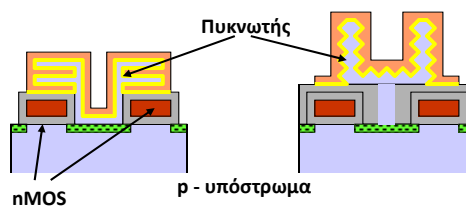

CMOS Τεχνολογία

21

Μικροηλεκτρομηχανικά Συστήματα

MEMS

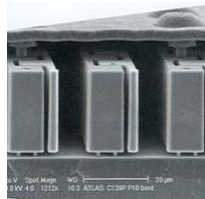
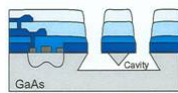
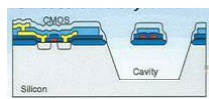

CMOS Τεχνολογία

22

Κατασκευαστικό Περιβάλλον



CMOS Τεχνολογία

23

Κανόνες Σχεδίασης – Design Rules

- Συνδεδειγμένος κρίκος μεταξύ σχεδιαστή και μηχανικού κατασκευής ολοκληρωμένων κυκλωμάτων
- Οδηγοί για τον τρόπο κατασκευής των μασκών για την υλοποίηση της σχεδίασης στο πυρίτιο
- Αντικατοπτρίζουν τους περιορισμούς και τα όρια της τεχνολογίας για την αξιόπιστη λειτουργία των κατασκευαζόμενων ολοκληρωμένων



CMOS Τεχνολογία

24

Επικόλληση Chip σε Πλακέτα

